



Simple, accurate, good value

F-Tool Product Line



Global presence

F-Tool is the product line in the EROWA portfolio for manual work in workpiece holding. This product line is optimized for use in EDM sinking and wire EDM.



F-TOOL PALLETIZING- AND TOOLING SYSTEMS

Systematic palletizing and clamping 4



F-Tool EDM 6



F-Tool WEDM 26

Index 55

Everything you need for manual work during EDM.
100% compatible with EROWA products.

Accurate, manual, affordable

The F-Tool (by EROWA) product line is aimed at cost-conscious newcomers to workpiece palletizing. But even experienced users will find some surprisingly useful products.

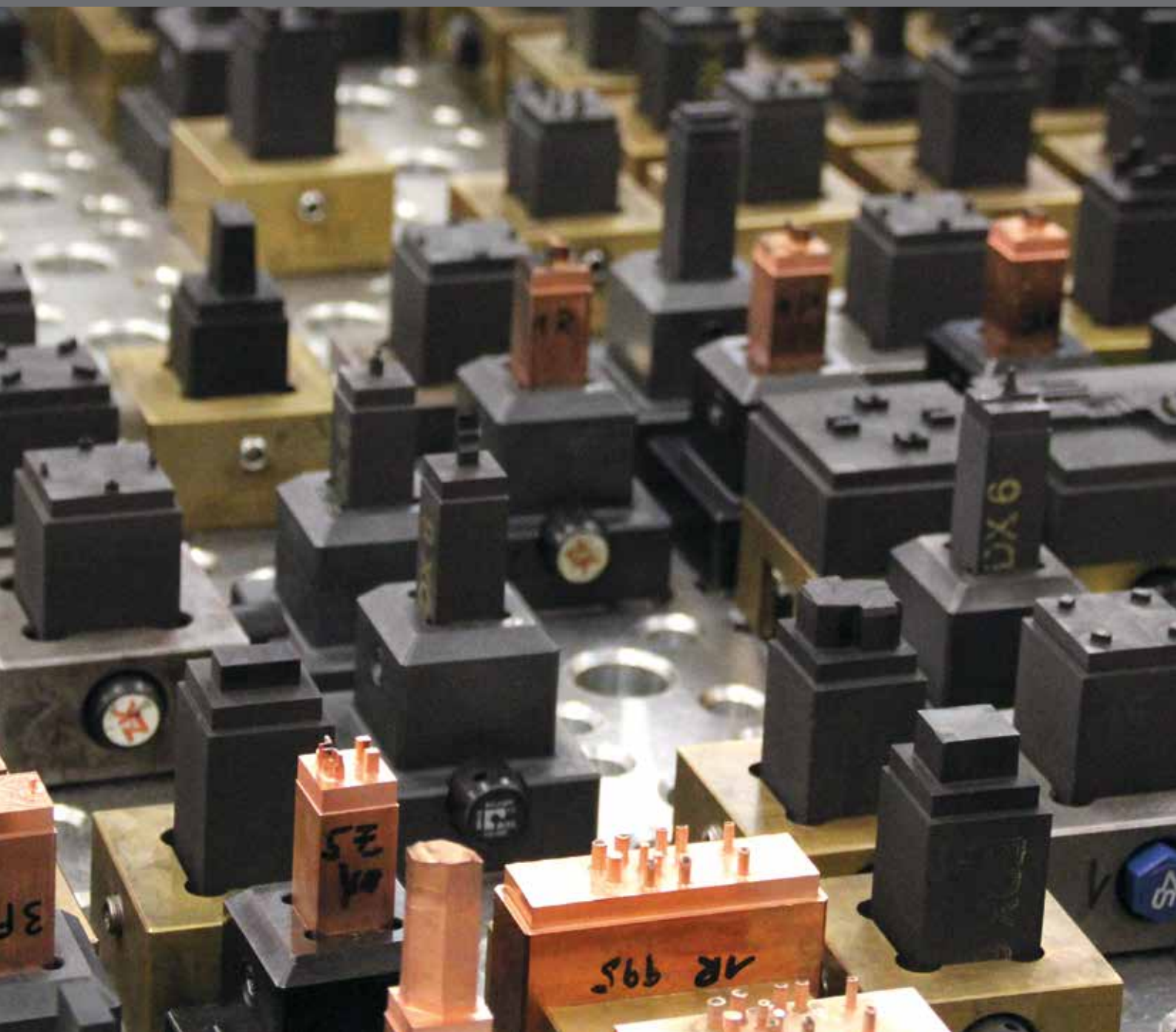

Increase productivity

In metalworking, productivity starts with eliminating machine downtime. This is achieved by capturing and using datum points/starting points. And this in turn is made possible by the use of F-Tool tooling systems.

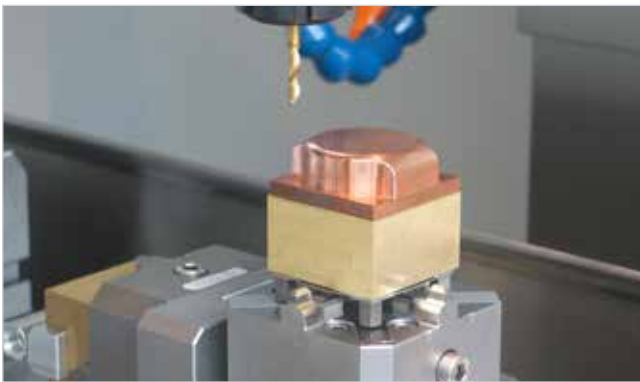

Complete electrode manufacturing - milling, drilling, turning.



Consistently from EDM sinking to ...

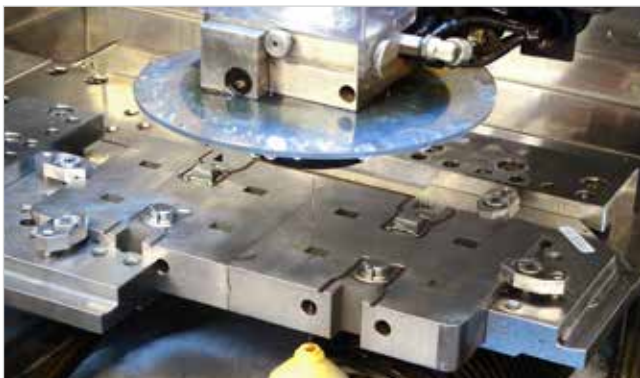

... wire EDM cutting..

THE FACTS

- Good value for money
- Accurate
- Practical
- Manual

Simple, convenient, good

Flexible and accurate clamping, robust machining, easy set-up - these are the obvious advantages of the F-Tool (by EROWA) products in EDM applications.

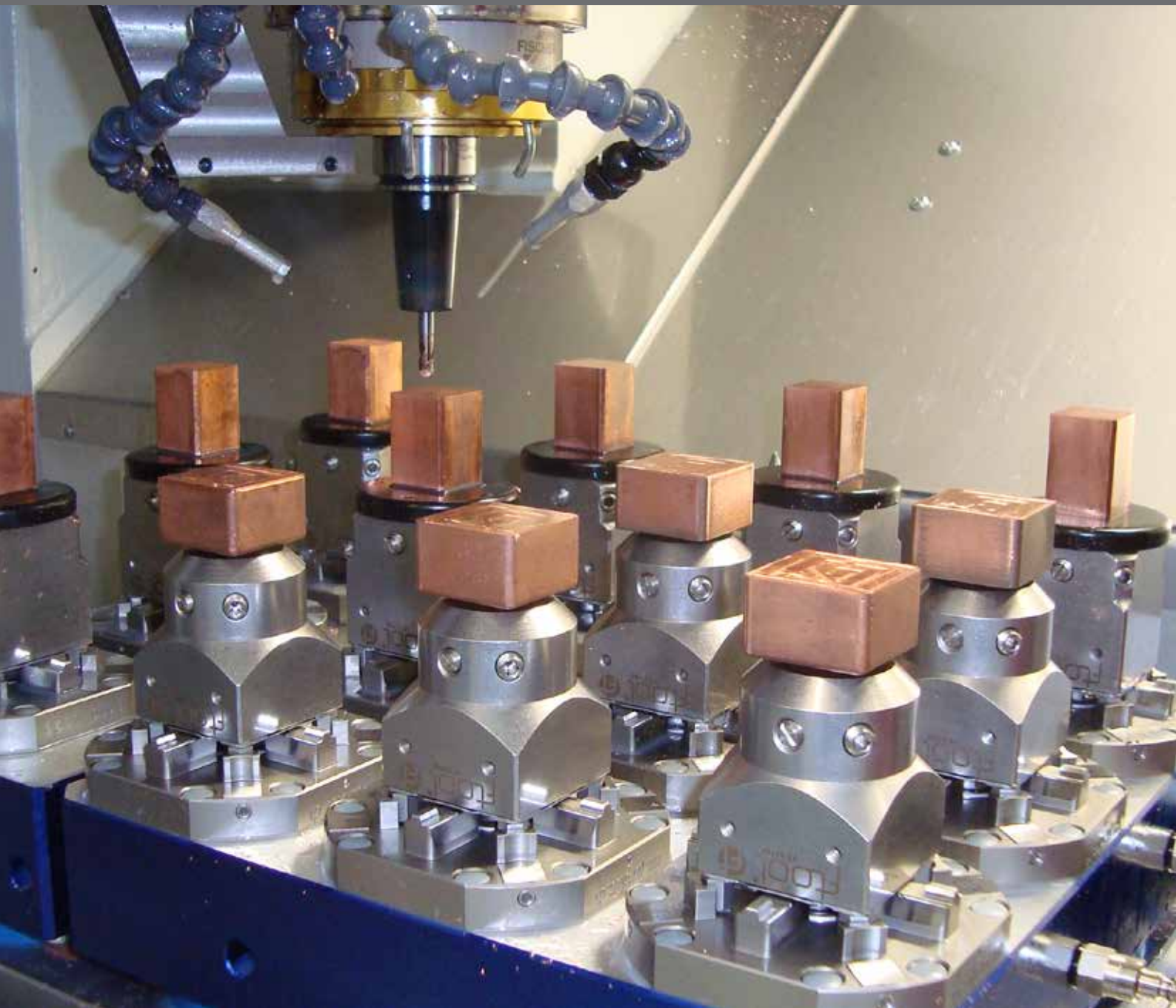

Simplify the world of EDM sinking

Transparent investments for significant improvements.



Quality - the F-Tool (by EROWA) product line also uses only the best materials and strict manufacturing tolerances are ensured.



The stability leaves nothing to be desired. Chucks from F-Tool work with a reliable clamping mechanism. The design of the housing guarantees high stability.



Simple operation is included with all components. The F-Tool chucks are manually operated. Installation on machine tables and fixtures is simple without compressed air supply.



















THE FACTS

- Easy installation
- Robust design
- Manual operation

Consistent interface



EDM clamping solutions are ideally adapted to the exacting requirements of tool and mold making and precision mechanics.



-  1. Manual operation
-  2. Operate with compressed air jet
-  3. Operate with manual valve
-  4. Operate with manual control unit
-  5. Operate with electro-pneumatic control unit
-  6. With central flushing clearance
-  7. Suited for submerged operation
-  8. Corrosion-resistant material
-  9. Suited for automatic operation
-  10. Handling with EROWA Robot gripper S
-  11. Handling with EROWA Robot gripper Combi
-  12. Handling with EROWA Robot gripper C
-  13. Handling with EROWA Robot gripper 72
-  14. Handling with EROWA Robot gripper 115
-  15. Handling with EROWA Robot gripper 148
-  16. Handling with EROWA Robot gripper RN PC 210
-  17. Handling with EROWA Robot gripper RCS
-  18. Handling with EROWA Robot gripper WGS-500

F-TOOL EDM TOOLING SYSTEM

F-Tool	Chucks	10
F-Tool	Electrode holders	12
F-Tool	Clamping beams	19
F-Tool	Accessories	23

-  For chip-removing processes
-  For EDM sinking
-  For WEDM

F-Tool

EDM Chucks

Technical data	Chucks
Repeatability	0,002 mm
Indexing pallet	4 x 90°
Clamping	manually
Automatable	no
Mounting height	51 mm

FT 02110 Chuck 50



Version	ITS chuck system size 50, manual, corrosion-resistant. Fixing with 4 x M8, hole pattern 44 mm, from back side or with 4 x M6 with stud bolts and screw nut. Use on EDM / WEDM machines and for milling, rotation and grinding jobs.
Application	Use on EDM / WEDM machines and for milling, rotation and grinding jobs.
Hint	Clamping force: 3'400 N - 5'500 N.

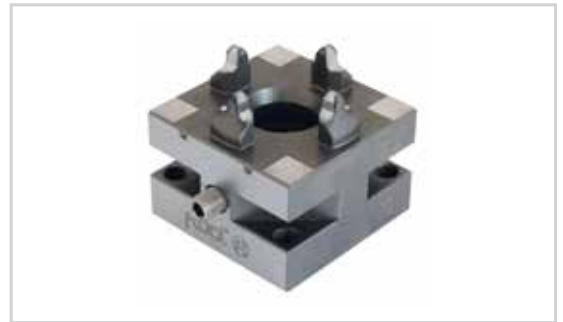

FT 01043 Chuck 80P



Version	Manual ER chuck. Hardened, stainless steel. For the system sizes ER 50 and 100. Hole pattern ER chuck: 8 x M6 TK \varnothing 61 x 45°.
Application	Use on EDM / WEDM machines and for milling, rotation and grinding jobs.
Hint	Clamping force: 3'400 - 7'000 N.



FT 02443 Manual Chuck 150P

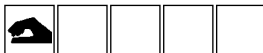

Version	Steel, hardened. Stable housing made of solid material. Repeatability 0.002 mm, Indexing 4 x 90°.
Application	The chuck can be opened and closed manually with a simple screw cap. The chuck is also suitable for grinding spindles and dividing heads.
Hint	Clamping force: 3'400 N - 7'000 N.



FT 01768 Extension ER-chuck 50 / L = 100 mm

Version Extension ER-Chuck 50 of stainless steel.

**FT 01769 Extension ER-chuck 50 / L = 200 mm**

Version Extension ER-Chuck 50 of stainless steel.

**FT 02120 EDM-BeautyCase Chuck 50**

Set contains

- 2 x FT 01073 Chucking spigot F/A EDM
- 2 x FT 02139 Prisround 25 mm ALU
- 2 x FT 02143 Uniholder 20 mm ALU
- 2 x Allen key with hand grip 4mm
- 1 x FT 02110 ER-Chuck 50
- 1 x Miscellaneous screws
- 1 x FT 02110 ERC-50 mounted on FT 02127 adapter plate with electric power and flushing connection.

Application For electrode manufacturing or for mounting on the head of an EDM machine.



F-Tool

EDM Electrode holders

FT 02131 Uniblank ALU (set of 10 pieces)

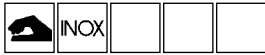

Version Fitted without machining of body.
 Application To mount electrodes and workpieces of various shapes.
 To fit blank As required.



FT 02132 Uniblank ALU EWIS™ (set of 10 pieces)



Version Fitted without machining of body.
 Application To mount electrodes and workpieces of various shapes.
 To fit blank As required.



FT 02133 Uniplate ALU (set of 10 pieces)



Version Surface 50 x 50 mm faced, including 2 x M6 bolts for each unit.
 Application To mount electrodes and workpieces with a base surface of more than 50 mm.
 To fit blank With 2 x M6 bolts into the base surface.



FT 02134 Uniplate ALU EWIS™ (set of 10 pieces)



Version Surface 50 x 50 mm faced, including 2 x M6 bolts for each unit.
 Application To mount electrodes and workpieces with a base surface of more than 50 mm.
 To fit blank With 2 x M6 bolts into the base surface.



**FT 02135 Prisround ALU 15 mm
(set of 10 pieces)**

Version Square 16.0 mm milled. Including 2 stud bolts. Fixed stop X, Y from the centre 7.5 +/- 0,05 mm. Clamping depth 19 mm, Fixed stop hZ = 22 +/- 0.05 mm.

Application To mount electrodes and work pieces with a shank size of less than 15 mm.

To fit blank Insert and tighten setscrews. If necessary, center with spacer plate FT 01092.

**FT 02136 Prisround ALU EWIST™ 15 mm
(set of 10 pieces)**

Version Square 16.0 mm milled. Including 2 stud bolts. Fixed stop X, Y from the centre 7.5 +/- 0,05 mm. Clamping depth 19 mm, Fixed stop hZ = 22 +/- 0.05 mm.

Application To mount electrodes and work pieces with a shank size of less than 15 mm.

To fit blank Insert and tighten setscrews. If necessary, center with spacer plate FT 01092.

**FT 02137 Prisround ALU 20 mm
(set of 10 pieces)**

Version Square 21.0 mm milled. Including 2 stud bolts. Fixed stop X, Y from the centre 7.5 +/- 0,05 mm. Clamping depth 19 mm, Fixed stop hZ = 22 +/- 0.05 mm.

Application To mount electrodes and work pieces with a shank size of less than 20 mm.

To fit blank Insert and tighten setscrews. If necessary, center with spacer plate FT 01092.

**FT 02138 Prisround ALU EWIST™ 20 mm
(set of 10 pieces)**

Version Square 21.0 mm milled. Including 2 stud bolts. Fixed stop X, Y from the centre 7.5 +/- 0,05 mm. Clamping depth 19 mm, Fixed stop hZ = 22 +/- 0.05 mm.

Application To mount electrodes and work pieces with a shank size of less than 20 mm.

To fit blank Insert and tighten setscrews. If necessary, center with spacer plate FT 01092.



F-Tool

EDM Electrode holders

FT 02139 Prisround ALU 25 mm (set of 10 pieces)



- Version Square 26.0 mm milled. Including 2 stud bolts. Fixed stop X, Y from the centre 7.5 +/- 0,05 mm. Clamping depth 25 mm, Fixed stop hZ = 22 +/- 0.05 mm.
- Application To mount electrodes and work pieces with a shank size of less than 25 mm.
- To fit blank Insert and tighten setscrews. If necessary, center with spacer plate FT 01092.



FT 02140 Prisround ALU EWIS™ 25 mm (set of 10 pieces)



- Version Square 26.0 mm milled. Including 2 stud bolts. Fixed stop X, Y from the centre 7.5 +/- 0,05 mm. Clamping depth 25 mm, Fixed stop hZ = 22 +/- 0.05 mm.
- Application To mount electrodes and work pieces with a shank size of less than 25 mm.
- To fit blank Insert and tighten setscrews. If necessary, center with spacer plate FT 01092.



FT 02141 Uniholder ALU 15 mm set of 10 pieces



- Version Slot 15.5 mm routed including 2 stud bolts. Clamping depth 13 mm. Fixed top hZ = 28 +/- 0.05 mm.
- Application To mount electrodes and work pieces with a clamping width up to 15 mm.
- To fit blank Insert and tighten setscrews. If necessary, center with spacer plate FT 01092.



FT 02142 Uniholder ALU EWIS™ 15 mm set of 10 pieces



- Version Slot 15.5 mm routed including 2 stud bolts. Clamping depth 13 mm. Fixed top hZ = 28 +/- 0.05 mm.
- Application To mount electrodes and work pieces with a clamping width up to 15 mm.
- To fit blank Insert and tighten setscrews. If necessary, center with spacer plate FT 01092.



**FT 02143 Uniholder ALU 20 mm
set of 10 pieces**

Version Slot 20.5 mm routed including 2 stud bolts. Clamping depth 13 mm. Fixed top hZ = 28 +/- 0.05 mm.

Application To mount electrodes and work pieces with a clamping width up to 20 mm.

To fit blank Insert and tighten setscrews. If necessary, center with spacer plate FT 01092.

**FT 02144 Uniholder ALU EWIS™ 20 mm
(set of 10 pieces)**

Version Slot 20.5 mm r outed including 2 stud bolts. Clamping depth 13 mm. Fixed top hZ = 28 +/- 0.05 mm.

Application To mount electrodes and work pieces with a clamping width up to 20 mm.

To fit blank Insert and tighten setscrews. If necessary, center with spacer plate FT 01092.

**FT 02194 Electrode holder ALU XL EWIS™
set of 10 pieces**

Version The electrode holder XL is prepared with central flushing hole \varnothing 5 mm. Delivered with stud bolts M8.

Application To mount electrodes and work pieces.

To fit blank The electrode holder can be finished at will. Two pinholes M8 for the lateral clamping are prepared.



F-Tool

EDM Electrode holders

FT 01077 Uniblack set of 10 pieces



Version Fitted without machining of body.
Application To mount electrodes and workpieces of various shapes.
To fit blank As required.



FT 01079 Uniplate set of 10 pieces



Version Surface 51 x 51 mm faced, including 2 x M6 bolts for each unit.
Application To mount electrodes and workpieces with a base surface of more than 50 mm.
To fit blank With 2 x M6 bolts into the base surface.



FT 01081 Prisround set of 10 pieces



Version Square 26.5 mm milled. Including 2 setscrews for each unit.
Application To mount electrodes and workpieces with a base surface of more than 50 mm.
To fit blank Insert and tighten setscrews. If necessary, center with spacer plate FT 01092.



FT 01084 Uniholder set of 10 pieces



Version Groove 20 mm faced. Including 2 setscrews for each unit.
Application To mount electrodes and workpieces with shaft sizes of up to 20 mm.
To fit blank Insert and tighten setscrews. If necessary, center with spacer plate FT 01092.



FT 01435 Steel Holder Inox EWIS™ set of 10 pieces



Version Steel, corrosion resistant. Set of 10 units, surface 52 x 52 mm faced, including 2 x M6 bolts for each unit.
Application To mount electrodes, work pieces and fixtures with a base surface of more than 50 mm.
To fit blank With two bolts M6 into the base surface. Hole distance between bolts 40 mm.



FT 01085 Collet chuck holder ETS32 / EWIS™

Ausführung Parameter EROWA ITS 50 or on 3R basis element.
 Anwendung For collet chucks ETS32.
 Hint Delivered without chucking spigots.

**FT 01581 Collet chuck holder ETS32 without adapter plate**

Version The collet chuck holder ETS32 is rust-resistant and able for the water bath.

**FT 01129 15 square clamp EWIS™**

Version Repeatability of the electrode blanks.
 Application For graphite and electrode blanks 15 x 15 mm, uttermost repeat accuracy, non-sensitive to soil and corrosion resistant.

**FT 01131 25 Square Clamp EWIS™**

Version Positioning / repeat accuracy of the electrode blanks
 Application For graphite and electrode blanks 25 x 25 mm, uttermost repeat accuracy, non-sensitive to soil and corrosion resistant.



F-Tool

EDM Electrode holders

FT 01762 Square 15 monobloc



- Version - Square 15 of stainless, hardened INOX steel with collet EROWA
 - 3 linear s top surfaces, hardened and jig rinded
 - Lateral flushing connection
 - Prepared for EWIS.
- Repeat accuracy Repeat accuracy +/- 0.005 mm, as well at changing electrodes in several holders.
- Hint Delivered without chucking spigot.



FT 01764 Square 15 front part



- Version - Square front part of stainless, hardened INOX steel -
 3 linear s top surfaces, hardened and jig rinded - For the assembling on pallets and plates for multiple clamping.
- Repeat accuracy +/- 0.005 mm.
- Hole pattern for 4 x M6 ø 6.5 mm.



FT 01793 Collet chuck holder ETS32 incl. index adapter plate 80



- Application Collet chuck holder with clamping nut for collet chucks ETS 32. The collet chuck holder is corrosion-resistant and under careful care he could be also inserted in the water.



FT 01835 PowerPlate



- Version Centering plate with P-profile, compatible with FT 01043 F-Tool ER chuck 80P, FT 02443 manual chuck 150P plus all EROWA chucks with P-profile, EROWA PowerChuck and EROWA ProductionChuck 210 Combi.
- Application For the direct assembling on pallets and fixtures.
- Hint Highly friction centering.



F-Tool

EDM Clamping beams

FT 01809 PIN MultiClamp 105 x 72 mm B40
corrosion-resistant

FT 01810 PIN MultiClamp 105 x 72 mm ITS50
corrosion-resistant



Application The F-Tool MultiClamp is a pull-down clamp with adjustable, hardened pull-down and stop jaws. It is corrosion-resistant and hardened. The stop jaw can be set every 2 mm in the tooth grid. The support surface is put up on 25 ± 0.01 mm. The F-Tool MultiClamp fits for the insert as a multiple clamp on the T-slot pallet, ITS/UPC pallet and square block. The maximum clamping range on the MultiClamp 105 is 48 mm, on the MultiClamp 181/124 mm. The clamp travel of the clamping jaw is 3 mm.



FT 01920 MultiClamp 105/35 for EROWA P 148

FT 01921 MultiClamp 181/35 for EROWA P 148



Application The MultiClamps 105/35 and 181/35 are designed to mount directly onto EROWA Standard pallets with hole pattern $4 \times M8 \varnothing 37$ mm respective $4 \times M8 110 \times 50$ mm. The table height is 35 ± 0.01 mm. The clamping range is identical to the FT 01809 respective FT 01811.



FT 01811 PIN MultiClamp 181 x 72 mm B40



Version The F-Tool MultiClamp is a precision pull-down chuck with adjustable, hardened pull-down and stop jaws. It is made of hardened, corrosion-resistant high-grade steel. Hole grid: 40mm. Suitable for a T-slot pallet or a grid plate.

Clamping range Amounts to a total of 124mm. The clamping range of the movable jaws is 3 mm.



F-Tool

EDM Clamping beams

FT 01882 MC railer 320 B72



- Version The multiclamp railer 320 B72 is made of rust-resistant material, hardened and precision ground.
- Dimension 320 x 72 x 35 mm, tooth grid 2 mm, hole grid \varnothing 12 x 50 mm. The railer fits on the pallet with hole grid 50 mm.



FT 01862 Precisions-prism reversible jaw S-72h19

FT 01863 Grip-prism reversible jaw SG-72h19

FT 02011 Fix stop jaw soft alu 38 x72 x h19 mm set of 5 pieces



- Application The F-Tool prism reversible jaws 19 mm are the standard sizes and can be assembled in the grid of 2 mm on the Multiclamp 105 and 181. According to the purpose of use, the surface-grinded, the prism side or for blanks, the grip-prism reversible jaw is appropriate.



FT 01864 Grip-prism reversible jaw F-72h12

FT 01865 Flat-grip reversible jaw FG-72-h12



- Application The prism reversible jaws 12 mm are suitable for the clamping of rather flat work pieces. The function is otherwise identical with the standard prism reversible jaws 19 mm. They can be used on the multiclamp 105 and 181.



FT 01866 Flat-clamping jaw set FC24-h12 set of 3 pieces

FT 01867 Flat-grip-clamping jaw set FCG24-h12 Set of 3 pieces





- Application The flat-clamping jaws are suitable for the use with the prism reversible jaw 12 mm. Applicable on multiclamp 105 and 181 as well as on the clamping blocks B72.
- Clamping force 4-5 kN/Clamping jaw.



FT 01877 Grip-clamping jaw set SCG24-h19 set of 3 pieces

FT 01905 Clamping jaw set SC24-h19 set of 3 pieces



Application  

The F-Tool clamping jaws have a clamping range of 3 mm. They can be used on the multiclamp 105 and 181, as well as on the clamping blocks B72. The lateral slot allows the attachment of supports FT 01868 or extension jaws FT 01887.

Clamping force 4-5 kN/clamping jaw.



FT 01883 MC clamping block B72/20 L58

Version  

The clamping block with fixed stop fits the railer 320 B72 and 400 B72. Made of rust resistant material, hardened and ground. With the three clamping jaws a tension can be caused of 3.5 t. The clamping principle of the clamping jaws produces an optimal pull-down effect.





FT 01884 MC double clamping block B72/20 L84

Application  

The F-Tool double clamping block is suitable for the multiple clamping on the MC railer B72.



FT 01885 MC stopper beam B20 / 30

Application  

Double acting stop to WEDM clamping beam B72 with 2 mm tooth rack, corrosion resistant and hardened.



F-Tool

EDM Clamping beams

FT 01886 MC stopper beam base B20 / 40



Application On these MC stopper beam bases, aluminium jaws or the F-Tool prism reversible jaws can be assembled.



FT 01813 PIN parallel support set 16 mm set of 2 pieces



Application The parallel support set is suitable for the flat clamping of work pieces, but can as well be used for parallel clamping. The bails avoid the drop-out while turning or while cleaning the vises with compressed air.



FT 01887 Extension jaw 22h13



Application The extension jaw bridges the level of the clamping blocks to the parallel clamping of high work pieces.



FT 02038 Support set B72 h25 set of 2 pieces



Application The F-Tool support set B72 h25 fits on the MC stopper beam FT 02035 and the clamping block FT 02036.



FT 01888 Alu jaw 72 x 60 x 14.5 mm



Application On these MC stopper beam bases, aluminium jaws or the F-Tool prism reversible jaws can be assembled.

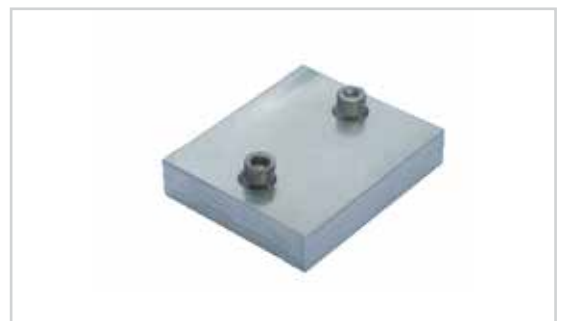

F-Tool

EDM Accessories

FT 01092 Insert plates 0.5 / 1 / 2 / 3 / 4 / 5 mm set of 300 pieces



Version Corrosion-resistant, thicknesses from 0.5 to 5 mm.
Application Centering of blanks in electrode holders.

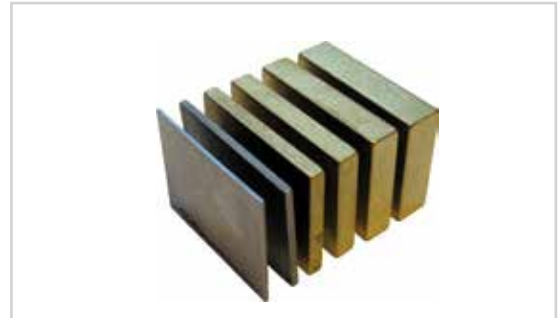

FT 01483 Square block chuck 80 / PIN chuck

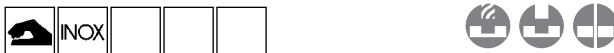

Version Accurate grinded square block, rustless, for the assembling of one or two ER chuck 80P (FT 01043), chuck 80 IF3R (FT 01044) or PIN center chuck (FT 01716) in vertical or horizontal position.
Application For the application with brackets on divers tooling machines.
Hint Spindle height at horizontal installation of the chuck: 75 mm.



FT 02106 Square block chuck 50



Application The square block ERC-50 is hardened, rust-resistant and ground very precise. The block is qualified optimally for the use on electrode milling, as angle adapter or as extension.



FT 02107 Universal adapter plate chuck 50 with flushing hole



Application The universal adapter plate ERC 50 with flush connection and electric cable fixation can be used as quill adapter on EDM machines or assembling plate on the machine tool.



F-Tool

EDM Accessories

FT 02349 Chucking spigot F/M EDM for flushing (set of 10 pieces)



Version Fixed type, manual. Bolt, length h 45 mm, with flushing hole.

Application In ITS electrode holders.



FT 02352 Chucking spigot F/A EDM for flushing (set of 10 pieces)



Version Fixed type, automatic. Bolt, length 45 mm, with flushing hole.

Application On all electrode holders that are changed automatically.



FT 02351 Chucking spigot F/M production set of 10 pieces



Version Fixed type, manual. Bolt 12.9, length 50 mm, without flushing hole.

Application In pallets for chip-cutting machining processes.



FT 02354 Chucking spigot F/A Inox set of 10 pieces



Version Fixed type, automatic. Bolt, length 45 mm, with flushing hole.

Application On all electrode holders that are changed automatically.



Modular, accurate, durable

These are three characteristics of the F-Tool (by EROWA) equipment for wire EDM. Whether table equipment or clamping device for the smallest parts, the solution is already available in the F-Tool wire EDM range.

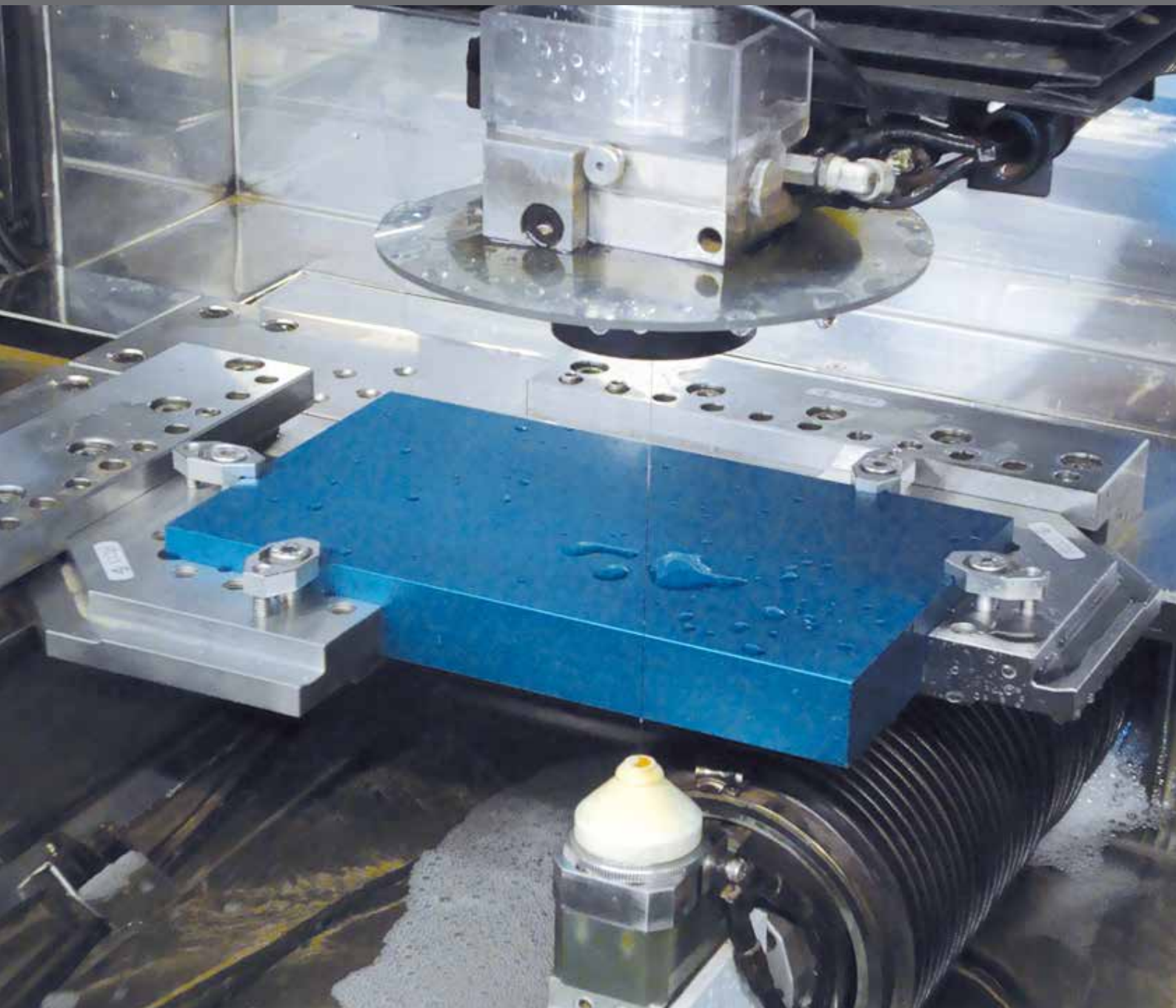

Simplify the world of wire EDM

Invest once and then use for a long time. The modular system of the wire EDM equipment opens up undreamt-of possibilities.

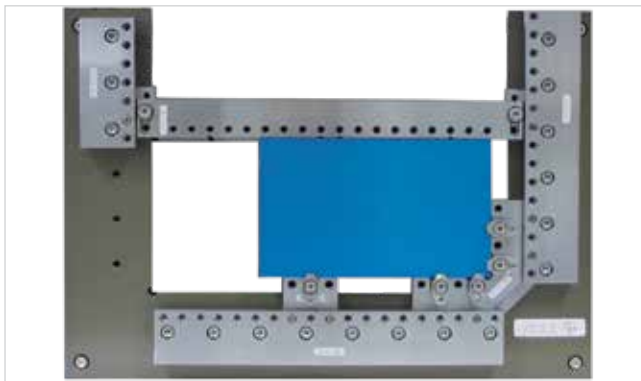

Ideal entry with the Rulerset. Ingeniously easy to use. Versatile for a wide range of workpiece shapes.



Extend your clamping possibilities exactly as required. Base rails for fast clamping of workpieces or other clamping elements in reference position.



The Mini universal clamping - simple and sophisticated. One of the many really useful parts in the F-Tool (by EROWA) WEDM tooling system.



















THE FACTS

- High quality
- Easy mounting
- Practical benefits

Consistent interface

Wire EDM clamping solutions optimally matched to the exacting requirements of tool and mold making and precision mechanics.



-  1. Manual operation
-  2. Operate with compressed air jet
-  3. Operate with manual valve
-  4. Operate with manual control unit
-  5. Operate with electro-pneumatic control unit
-  6. With central flushing clearance
-  7. Suited for submerged operation
-  8. Corrosion-resistant material
-  9. Suited for automatic operation
-  10. Handling with EROWA Robot gripper S
-  11. Handling with EROWA Robot gripper Combi
-  12. Handling with EROWA Robot gripper C
-  13. Handling with EROWA Robot gripper 72
-  14. Handling with EROWA Robot gripper 115
-  15. Handling with EROWA Robot gripper 148
-  16. Handling with EROWA Robot gripper RN PC 210
-  17. Handling with EROWA Robot gripper RCS
-  18. Handling with EROWA Robot gripper WGS-500

F-TOOL WEDM TOOLING SYSTEM

F-Tool	Interfaces to machine table	30
F-Tool	Clamping beams	37
F-Tool	Adapter	41
F-Tool	Front spanners	42
F-Tool	Vises	46
F-Tool	3D Swivel head	48
F-Tool	Square block-index-table	50
F-Tool	Accessories	52



For chip-removing processes



For EDM sinking



For WEDM

F-Tool

WEDM Interfaces to machine table

FT 01344 Ruler set

Version The F-Tool ruler set is an economic basis equipment. Suitable for all wire EDM machines with basis zero table and hole pattern 50 mm M8 and hole pattern from table edge 30 - 40 mm.

Set contains

- 2 x FT 01349 FT basic ruler 230 mm
- 2 x FT 01350 front spanner
- 1 x FT 01352 corner set 85
- 2 x FT 01376 stopper
- 2 x FT 01457 Spacer Plate 100 x 29 x 3 mm
- 2 x FT 01947 F-Tool Spacer plate 60 x 29 x h3 mm
- comprehensive clamping applicances with support plates / brackets / screws / keys.

**FT 02128 Ruler set Z +3 mm**

Version The F-Tool ruler set is an economic basis equipment. Suitable for all wire EDM machines with basis zero table and hole pattern 50 mm M8 and hole pattern from table edge 30 - 40 mm.

Set contains

- 2 x FT 01349 FT basic ruler 230 mm
- 2 x FT 01790 Front spanner special +3 mm
- 1 x FT 01789 Corner set 85 special +3 mm
- 2 x FT 01376 stopper
- comprehensive clamping applicances / brackets / screws / keys.

**FT 01342 Ruler set ML**

Version The F-Tool ruler set ML is alike the ruler set FT 01344 but with basic rulers 230 mm ML. Suitable for all wire EDM machines with basis zero table and hole pattern 50 mm ML and hole pattern from table edge 30-55 mm.

Set contains

- 2 x FT 01780 basic ruler 230 mm ML
- 2 x FT 01350 front spanner
- 1 x FT 01352 corner set 85
- 2 x FT 01376 stopper
- 2 x FT 01457 Spacer Plate 100 x 29 x 3 mm
- 2 x FT 01947 F-Tool Spacer plate 60 x 29 x h3 mm
- comprehensive clamping applicances with support plates / brackets / screws / keys.



FT 01347	Basic ruler 140 mm
FT 01348	Basic ruler 180 mm
FT 01349	Basic ruler 230 mm
FT 01486	Basic ruler 320 mm
FT 01487	Basic ruler 380 mm



Application The basic ruler are adjusted to the coordinate system of the machine and provide afterwards a fast clamping of work pieces or F-Tool pallets and clamping elements in reference position.

Set contains
 - 1 x basic ruler
 - 1 x FT 01376 stopper / the required attachment and pressure screws (FT 01373).

Basic rulers standard Suitable for machine tables with hole pattern 50 mm from table edge 30-40 mm.



FT 01858	Basic ruler 140 mm ML
FT 01859	Basic ruler 180 mm ML
FT 01780	Basic ruler 230 mm ML
FT 01860	Basic ruler 320 mm ML
FT 01820	Basic ruler 380 mm ML



Application The basic ruler are adjusted to the coordinate system of the machine and provide afterwards a fast clamping of work pieces or F-Tool pallets and clamping elements in reference position.

Set contains
 - 1 x basic ruler
 - 1 x FT 01376 stopper / the required attachment and pressure screws (FT 01373).

Basic rulers with long hole Suitable for machine tables with hole pattern 50 mm from table edge 30-55 mm.



FT 01333	Chuck 50 with IF angle QC50
----------	-----------------------------



Application ER-Chuck 50 (FT 02110) assembled on WEDM angle (FT 01337) for the fast clamping with the F-Tool basic ruler.

Arbor height 28 mm.



F-Tool

WEDM Interfaces to machine table

FT 01334 Chuck 80P with WEDM IF angle 80



Application ER chuck 80P (FT 01043) assembled on WEDM angle (FT 01338). For the fast clamping with the F-Tool stop beads (basic ruler).

Arbor height 40 mm.



FT 01345 Corner basic set 14/85



Application The corner basic set 14/85 is a simple, economic and flexible way to clamp the pieces in the wire cutting machine. The corner 14/85 can be fixed in three different directions in the machine and can cut small as well as big work pieces with the best possible accessibility. The removable supporting bracket allows to cut the piece without any collision risk of the below wire guide in the highest precise and fastest zero position.



FT 02045 Corner Set 14/85



Application The corner set 14/85 supports the direct insert in the basic rulers.



FT 02044 Corner 14/85



Application The corner set 14/85 supports the direct insert in the basic rulers.



FT 01352 Corner set 85

Application The corner set is the perfect pallet for wire EDM plants. The corner set can be fixed left side, right side as well as frontal over 45°. The parts can be clamped outside the machine in the corner set and afterwards be clamped with the bead stops (basic ruler) in reference position of the machine. The clamping lips are lying in basic position on zero level.

Dimension Leg length 135 x 135 mm / height = 22 mm.
Set contains
 - 1 x corner
 - 2 x FT 01070 spacer plate 100 x 29 x 3 mm
 - screws / keys / brackets / support plates.

**FT 01420 Corner 85**

Application The corner can be fixed left side, right side as well as frontal over 45°. The parts can be clamped outside the machine in the corner and afterwards be clamped with the bead stops (basic ruler) in reference position of the machine. The clamping lips are lying in basic position on zero level

Dimension Leg length 135 x 135 mm / height = 22 mm.
Set contains
 - 1 x Corner.

**FT 01675 Corner set 85 special with adjusting screws**

Application The corner can be fixed left side, right side as well as frontal over 45°. The parts can be clamped outside the machine in the corner and afterwards be clamped with the bead stops (basic ruler) in reference position of the machine. The clamping lips are lying in basic position on zero level.

Dimension leg length 135 x 135 mm / height = 22 mm.
Set contains
 - 1 x Corner
 - 2 x FT 01070 spacer plate 100 x 29 x 3 mm
 - screws / keys / brackets / support plates.



F-Tool

WEDM Interfaces to machine table

FT 01789 Corner set 85 special +3 mm

Application The corner can be used on the left or on the right, as well as frontally around 45°. The parts can be clamped outside the machine and then clamped into the reference position of the machine with the alignment checking rails (based rails). In the original position, the clamping ledges are 3 mm above zero level.

Dimension Arm length: 135mm x 135mm / height: 22mm.
The set contains - 1 corner - various bolts, keys, brackets and supports

**FT 01346 3D ViseSet 100**

Application Fast, precise and three-dimensional adjustment. A universal and multifunctional set. Quick assembling with the basic ruler 140 mm. Compatible to WEDM-machines with Z-reference height 0.

Set contains - 1 x FT 01697 3D swivel head IF 22
 - 1 x FT 01347 basic ruler 140 mm
 - 1 x FT 01319 vise 100F22
 - diverse screws and keys delivered in a synthetic case.

**FT 02046 3D ViseSet 220B28**

Version Fast, precise and three-dimensional adjustment. Flexible machining of cubic pieces of miscellaneous sizes in Z-zero position. Accurate, strong and centrally clamping, simplifies the adjustment.

Maximal workpiece size 130 x 100 x 100 mm.

Maximal weight 10 kg.

**FT 02047 3D ViseSet 220B28 incl. basic ruler 140**

Version Fast, precise and three-dimensional adjustment. Flexible machining of cubic pieces of miscellaneous sizes in Z-zero position. Accurate, strong and centrally clamping, simplifies the adjustment.

Maximal workpiece size 130 x 100 x 100.

Maximal weight 10 kg.



FT 02108 3D ViseSet 320B28

Version

The 3D ViseSet is equipped with a 320 mm-long clamping rail. It serves to clamp workpieces of up to 330x100x100 mm and to adjust them independently in three levels.

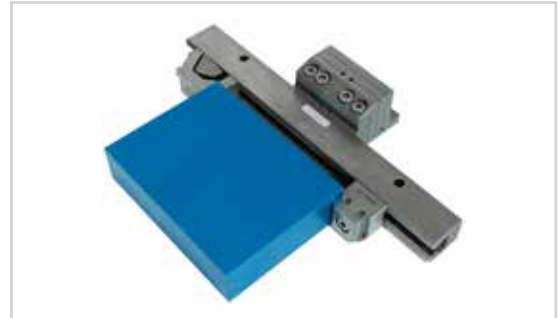
**FT 01924 WEDM clamping beam 220 with sliding jaws B28**

Version

The WEDM railer is prepared with a disc pull-down-system and a quickly adjustable clamping-slide. With the help of the basic rulers IF FT 01873 or with the two fixing holes $\varnothing 9$ D200, the railer can be clamped horizontal in the EDM wire cutting machine.

Maximal holding capacity

130 mm.

**FT 01925 WEDM clamping beam 320 with sliding jaws B28**

Maximal holding capacity

The WEDM railer is prepared with a disc pull-down-system and a quickly adjustable clamping-slide. With the help of the basic rulers IF FT 01873 or with the two fixing holes $\varnothing 9$ D200, the railer can be clamped horizontal in the EDM wire cutting machine.

2 x 0-88 mm or 1 x 0-230 mm.

**FT 01926 Clamping beam 220 B28**

Version

The railer is hardened and made of rustless steel. The grinded cog-grid is 2 mm.



F-Tool

WEDM Interfaces to machine table

FT 01927 Clamping beam 320 B28

Version

The railer is hardened and made of rustless steel.
The grinded cog-grid is 2 mm.

**FT 01929 High accuracy double stopper B28WEDM**

Version

The double stopper is equipped with the
disc-pull-down-system and a micro-pitch.

**FT 01928 High accuracy clamping jaw B28WEDM**

Application

The quickly adjustable clamping jaw is suitable for the
EDM wire cutting or in the high-precision mechanics. The
disc pulldown-system is suitable excellent for the clamping
of grinded pieces. Additional with micro-pitch.

**FT 01934 Clamping jaw B28 with pull down stopper**

Application

With the spring borne pull-down clamping jaw you can
clamp strongly in no time at all. The clamping range is 3 mm.



F-Tool

WEDM Interfaces to machine table

FT 02333 Micro Cutting StarterSet



Version The smaller a work pieces, the more challenging it is to clamp in a selected, aligned position. The F-Tool watch maker wire tool set is the suitable support, when flat plates or subtles tamps have to be clamped fast and accurate in the EDM wire cutting machine.

Set contains

- 1 x watch-maker wire tool set
- 1 x FT 01349 basic ruler 230 mm
- 1 x FT 01951 mini Universal clamping plate
- 6 x FT 01952 small brackets
- 4 x jack brass \varnothing 9.5 x 10 mm for M6
- 1 x hex key 3 mm (long)
- various screws.



FT 02150 Watch-maker wire tool set



Version The clamping set is intended for a small high-precision oil- and water-bath WEDM machines. The clamping set provides numerous clamping options of thin plates, as well as find dies and workpieces.

The set contains

- 1 x Watch-Maker Clamping Set
- 4 x mini brackets
- 1 x brass thrust pad
- 1 x hex kex 3mm (long)
- various bolts



F-Tool

WEDM Clamping beams

FT 01327 Beam L = 220 mm with clamping lips

FT 01063 Beam L = 300 mm with clamping lips

FT 01064 Beam L = 380 mm with clamping lips

FT 01065 Beam L = 460 mm with clamping lips



Application The beams are accurate grinded and consist of hardened, corrosion-resistant, alloyed high-grade steel. The beams are furnished with clamping lips for the work piece clamping on one side and on the other side they can be clamped frontal. With the spacer plates 3 mm (FT 01439) the 3 mm high clamping lip can be lifted over the collision zone. On the beams without Z-support you can assemble the Z-discs (FT 01911) and the Z-0 base plate (FT 01906).

Set contains

- 1 x beam
- 2 x FT 01439 spacer plate 60 x 20 x 3 mm
- 2 x countersunk screw corrosion-resistant M8 x 25 mm
- 2 x FT 01377 slide disc.

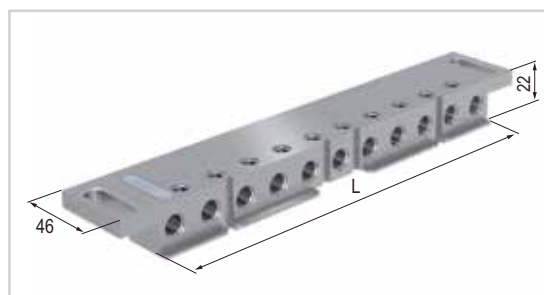

F-Tool

WEDM Clamping beams

FT 01826	Clamping beam L = 300 / H22 without Z Support
FT 01827	Clamping beam L = 380 / H22 without clamping lip
FT 01828	Clamping beam L = 460 / H36 without Z Support



Application The beams are accurate grinded and consist of hardened, corrosion-resistant, alloyed high-grade steel. The beams are furnished with clamping lips for the work piece clamping on one side and on the other side they can be clamped frontal. With the spacer plates 3 mm (FT 01439) the 3 mm high clamping lip can be lifted over the collision zone. On the beams without Z-support you can assemble the Z-discs (FT 01911) and the Z-0 base plate (FT 01906).

Set contains
 1 x beam
 2 x FT 01439 spacer plate 60 x 20 x 3 mm
 2 x countersunk screw corrosion-resistant M8 x 25 mm
 2 x FT 01377 slide disc.

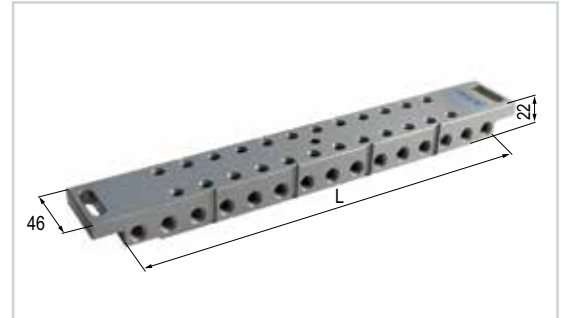

FT 02465	Clamping beam 550x60x30 mm / A=480 mm
FT 02467	Clamping beam 490x60x30 mm / A=420 mm
FT 02468	Clamping beam 565x60x30 mm / A=495 mm
FT 02469	Clamping beam 465x60x30 mm / A=395 mm
FT 02473	Clamping beam 439x60x30 mm / A=369 mm
FT 02482	Clamping beam 740x60x40 mm / A=670 mm



Application Clamping of workpieces with clamping claws on Z-discs. The beams are accurate grinded and consist of hardened, corrosion resistant, alloyed high grade steel.. With the distance plate set 3 mm, set of 2 (FT 02466) the position can be lifted over the collision zone. The workpiece level can be levelled with the 4 pressure screws.

Set contains
 1 x beam
 4 x pressure piece
 4 x pressure bolt M8x16
 1 Set FT 02466 spacer plates set 3 mm / set à 2 pieces
 2 x ER 071901 Z Support
 2 x ER 007729 Z support washer $\varnothing 12.5/28 \times 3$ mm
 2 x ER 129968 bracket
 4 x ER 000806 countersunk I6KT M8 x 16 mm
 2 x ER 017920 special countersunk M8 x 14 mm
 2 x ER 019884 cylinder screw I6KT M8 x 40 mm
 with a low head.

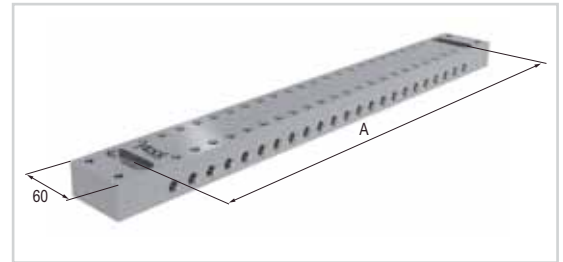

FT 01568	Interface plate 35 / 55 mm h=14 mm
FT 01569	Interface plate 45 / 75 mm h=14 mm
FT 01570	Interface plate 65 / 85 mm h=14 mm
FT 01825	Interface plate 65 / 95 mm h=14 mm

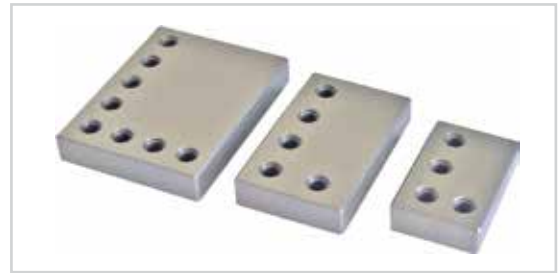

Application With the combination of F -Tool beam interfaces, span lengths in 5mm steps, from 70 mm to 170 mm can be bridged. The beams can be assembled side ways or lengthwise.

Length calculation of the clamping beams and connecting plates

At the insertion of the F-Tool basic ruler, the required bridging width calculates as follows:

Hole distance assembling basic ruler (A) -20 mm -clamping beam length (L) = length total (C)

Example:

RFI2050A 320 -20 -L 220 = C 80 this corresponds the length C 1 / 35 mm und C 2 / 45 mm

AQ537LA 470 -20 -L 300 = C 150 this corresponds 2 x lengths C 1 / C 2 = 75 mm

or

AQ537LA 470 -20 -L 380 = C 70 this corresponds 2 x lengths C 1 / C 2 = 35 mm

Combination examples:

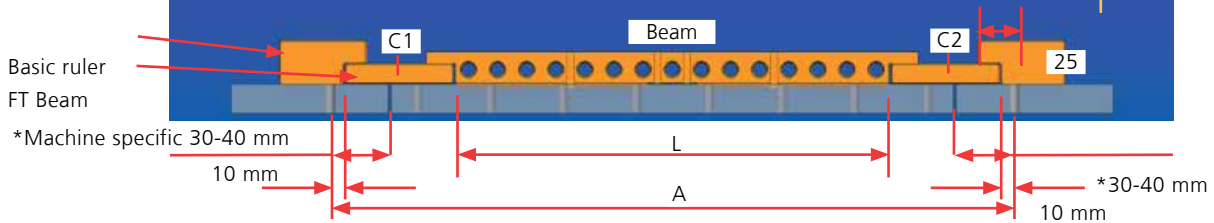
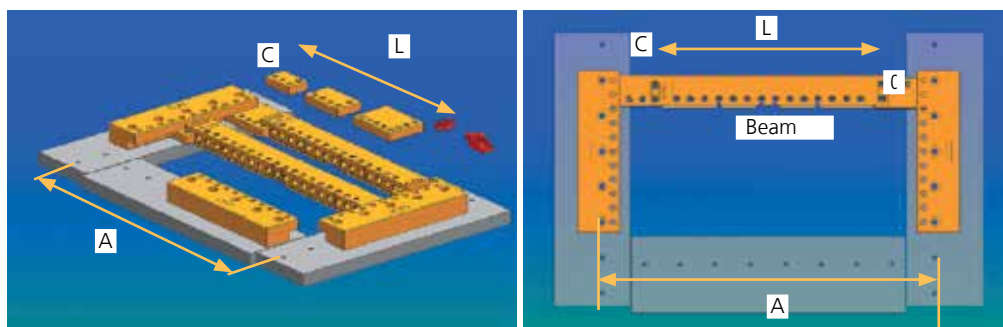

F-Tool

WEDM Clamping beams

FT 02097 Brass corner jaw block M6 set of 2 pieces



Application The brass corner jaw block is an easy tool to clamp work pieces on Z-0 levels and miscellaneous F-Tool clamping elements with hole grids 20 mm, designed to preclude any collisions.



FT 02149 Universal clamping-beam support 108 x 80 x 14 mm, set of 2 pieces

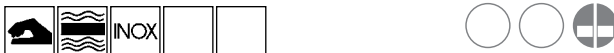

Application The F-Tool universal clamping beam supporting plates can be clamped directly on the machine table, without basic rulers. Miscellaneous table sizes and beam lengths can be bridged by movement on the side. In the single application you can add a FT 01906 Z-0 base plate to the supporting plate and use it as a clamping plate.

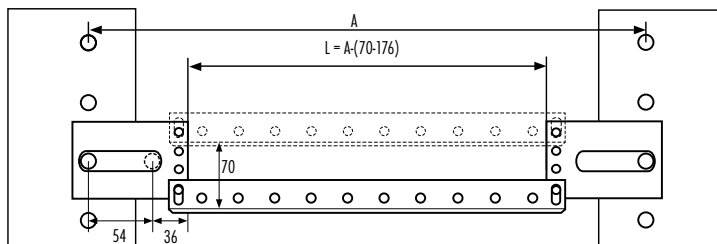

Choosing the clamping beam length (L)

Beam L		Article	=	A-Min.	A-Max.
220	+	FT 02149	=	290 mm	396 mm
300	+	FT 02149	=	370 mm	476 mm
380	+	FT 02149	=	450 mm	556 mm
460	+	FT 02149	=	530 mm	636 mm



FT 02149

Examples of use

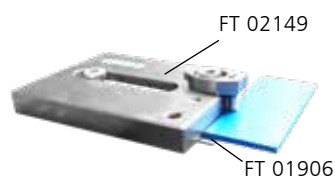

FT 02149 F-Tool Universal clamping beam supporting plate in the single application can be used with FT 01906 Z-0 support plate as clamping plate.

F-Tool

WEDM Adapters

FT 01873 Basic Ruler IF100/30



Application The basic ruler IF100/30 adapter is suited for the collet of the several beams, the front spanner 140 (FT 01572) or other installations directly into the ruler set (FT 01344).



FT 01878 Basic Ruler adapter IF100/50



Application The basic ruler adapter IF100/50 is suitable for clamping the PIN MultiClamp 105 (FT 01809 + FT 01810), PIN Multiclamp 181 (FT 01811), the clamping rail 320 (FT 01882) or other devices in the F-Tool RulerSet (FT 01344).



F-Tool

WEDM Front spanners

FT 01350 Front spanner



Version The front spanner provides a support plate for small parts or can be used in combination with the side spanner (FT 01351), the corner set 85 (FT 01352) or with the distance support mini (FT 01066). The clamping lip lies in basic position on zero level. This zero level can be hoisted 3 mm with the spacer plates. Clamping section of front spanner +3 mm, is 3 mm above Z=0 to avoid collision with lower guide.

Dimension 55 x 60 mm / height = 22 mm.

Set contains
- 1 x front spanner
- 2 x FT 01382 F-Tool bracket ER34 corrosion-resistant.



FT 01690 Front spanner Z-Vario



Application The front spanner special + 3mm (FT 01790) is built in the way the clamping surface is +3 mm above Z = Zero. This allows the lower arm of the wire machine to work always outside of the collision zone.

Dimension 55 x 68 mm / height = 22 mm.



FT 01790 Front spanner special +3 mm

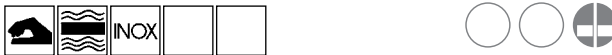

Application The front spanner provides a support plate for small parts or can be used in combination with the side spanner (FT 01351), the corner set 85 (FT 01352) or with the distance support mini (FT 01066). The clamping lip lies in basic position on zero level. This zero level can be hoisted 3 mm with the spacer plates. Clamping section of front spanner +3 mm is 3 mm above Z=0 to avoid collision with lower guide.

Dimension 55 x 60 mm / height = 22 mm.

Set contains
- 1 x front spanner
- 2 x FT 01382 F-Tool bracket ER34 corrosion-resistant.



FT 01951 Mini Universal clamping plate Z+2// 60 x 54 x 12 mm



Application The Mini Universal clamping plate, to fix thin plates in the F-Tool RulerSet. The z-lip supports are just +2 mm above the 0-level to avoid any collision with the flushing nozzle. The z-lips on both sides of the clamping plate give a high flexible application range. The clamping plate can be mounted as a single-, or over the corner as a multifunctional clamping device. The Mini clamping plate is delivered with two Mini brackets.



FT 01952 Mini Bracket 22 x 13 x 3.8 mm

Application Brackets corrosion-resistant for the miscellaneous clamping elements.

**FT 01351 Side spanner**

Application The F-Tool side spanner has two bearing sides and provides a support of larger plates. The side spanner is suited excellent in combination with the corner set 85 (FT 01352) or with the front spanner (FT 01350).

Dimension 215 x 50 mm / height = 22 mm.

Set contains
- 1 x side spanner
- 1 x FT 01439 spacer plate 60 x 20 x 3 mm.

**FT 01572 Front Spanner 140 x 30 x 35 mm complete with brackets**

Application For the direct collet of miscellaneous work pieces. As option to the swivel table IF 90° (FT 01356), to the 3D swivel with front spanner (FT 01693) and to the WEDM square block-index-table 80 (FT 01791).

**FT 01679 V-block**

Application The V-Block is qualified for the fast clamping of arbors, punches and pushers up to $\varnothing 32$ mm. It can be assembled frontally or from the back on diverse F-Tool holders. The best compatibility is with the F-Tool ER-plate EWIS (FT 01435) and the F-Tool universal index adapter plate 80 with graduation (FT 01792). For the application on EDM, WEDM and grinding machines.



F-Tool WEDM Front spanners

FT 01600 Z-Flex



Application The Z-Flex could be clamped frontal in all clamping beams with cross holes \varnothing M10, distance 20 mm, or in the front spanners FT 01350 and FT 01572. With the Z-Flex you could adjust the supporting surface in state of the clamped work piece on 0.2 mm. Appropriate for the levelling of plates and work pieces. Delivered with brackets and allen keys.



FT 01760 Z-Flex support 170 mm

FT 02307 Z-Flex mini support 80 mm



Application The Z-Flex support is ideal for clamping big plates. The Z-Flex support can be clamped directly on the machine table. In combination with the Z-Flex the workpiece can be levelled after clamping. The Z-Flex can be mounted in front, at right or at left hand of the Z-Flex support. The Z-Flex support can be fixed on both sides and allows, in combination with the Z-Flex, the clamping of the workpiece on Z0 or Z+3 mm.



Combination examples:

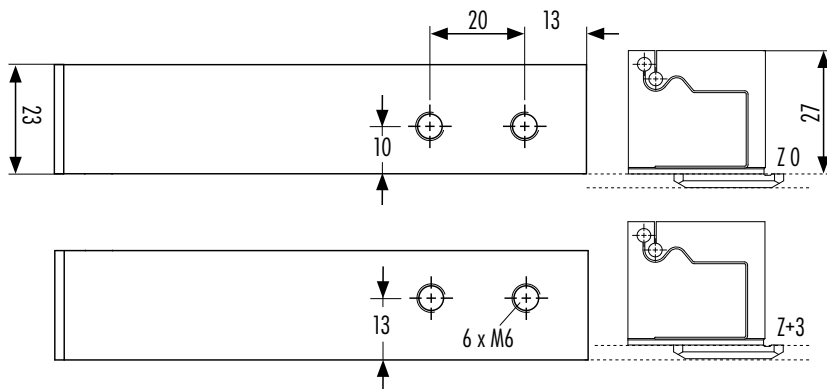
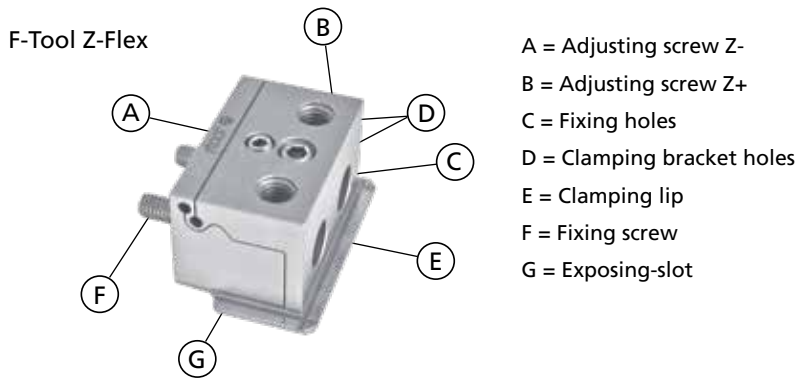

F-Tool Z-Flex support

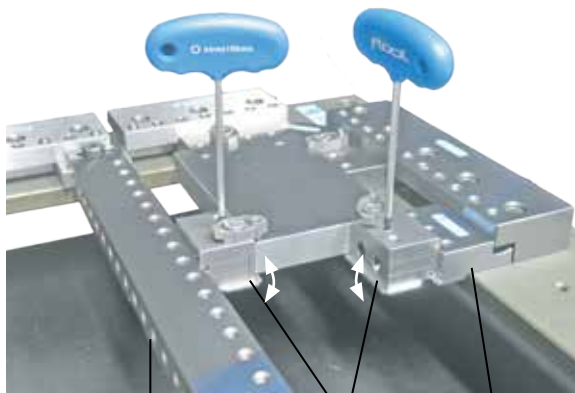
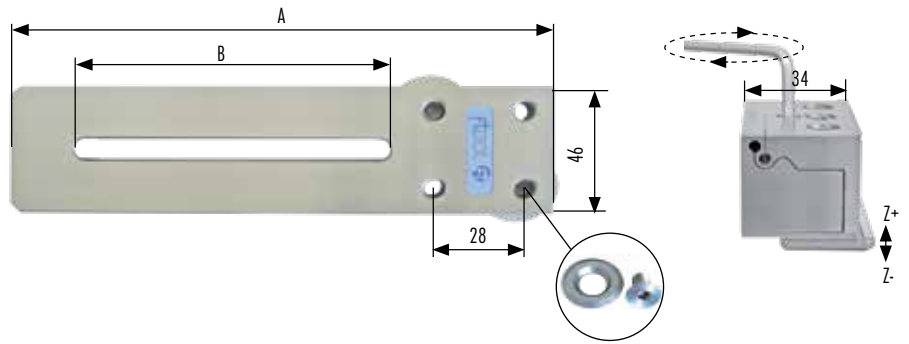

FT 01063-65 / FT 01327 FT 01600 FT 01350

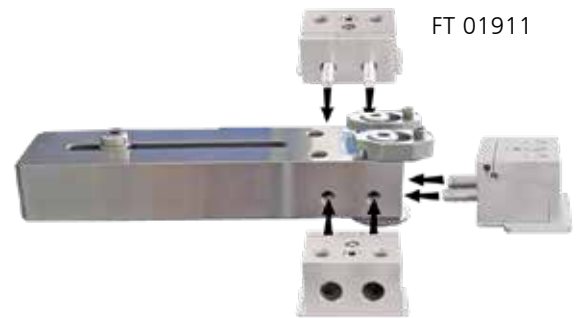

The F-Tool Z-Flex (FT 01600) can be assembled on the front, the left and the right side of the Z-Flex support (FT 01760).

F-Tool

WEDM Vises

FT 01318 WEDM vise 55F18



Application Handy, flat accurate vise (18 mm) with pull-down spring return effect for wire EDM plants. Can be inserted in the F-Tool ruler set, in the ER swivel, in the swivel table or in the palletset W. Made of corrosion-resistant, hardened high-grade steel.

Clamping length 55 mm.

Clamping height 18 mm.



FT 01319 WEDM vise 100F22



Application Handy, flat accurate vise (22 mm) with pull-down spring return effect for wire EDM plants. Can be inserted in the F-Tool ruler set, in the ER swivel, in the swivel table or in the palletset W. Made of corrosion-resistant, hardened, grinded high-grade steel.

Clamping length 100 mm.

Clamping height 22 mm.



FT 01326 Magnetic table 140 x 50 x 44 mm



Application Small, corrosion-resistant magnetic table for the insertion on EDM, wire EDM and grinding machines.

Hole pattern from behind 4 x M8 / 25 x 127 mm.



F-Tool

WEDM 3D Swivel head

The 3D swivel head can be adjusted quickly, precisely and three-dimensionally. In addition to many F-Tool clamping elements, it is compatible with EROWA and 3R clamping systems. It can be prepared and aligned outside the machine on a measuring station and is clamped on the F-Tool base strip of the machine table.

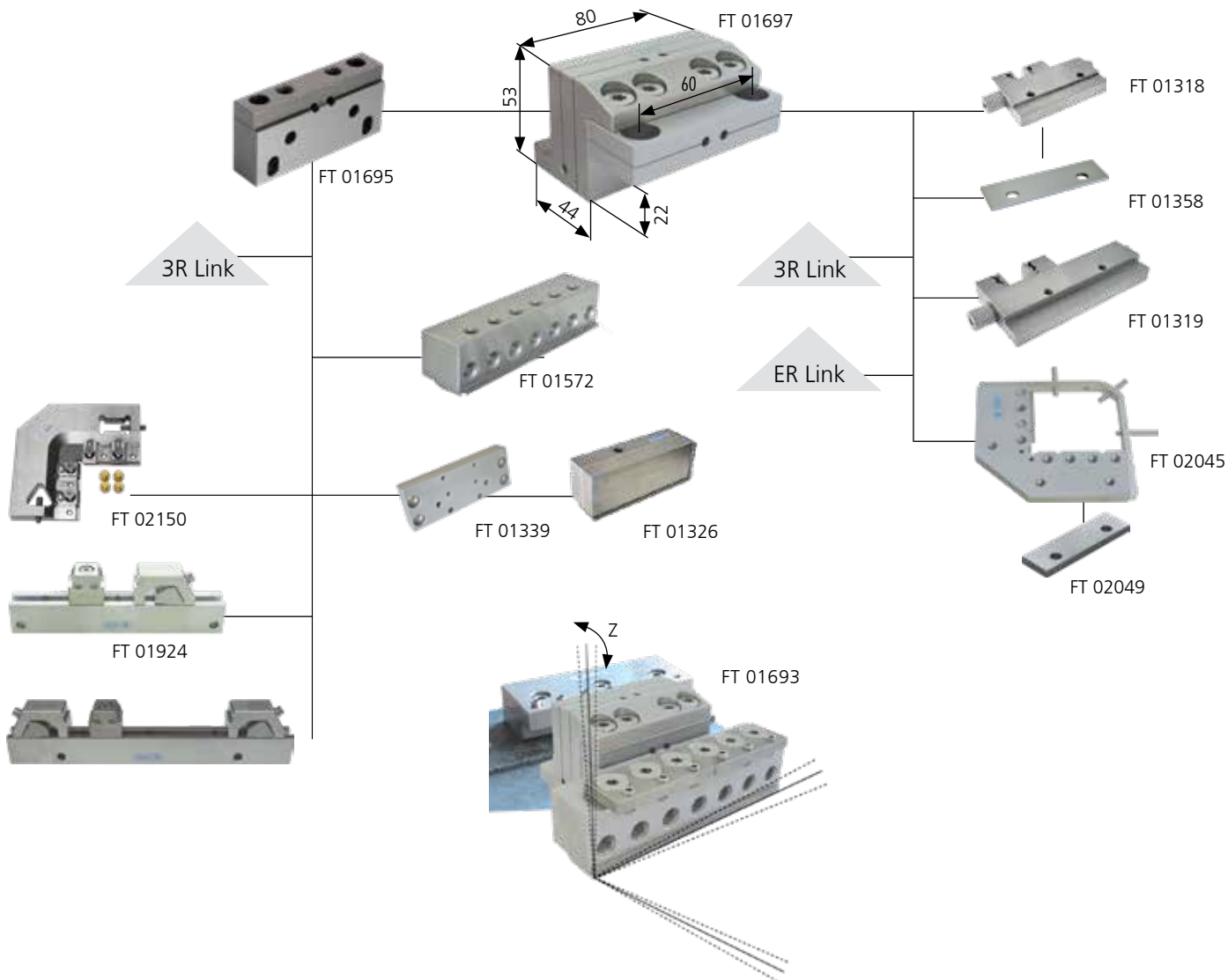

FT 01693 3D swivel head with front spanner 140



Application

The 3D swivel head with front spanner 140 is delivered completely with screws, brackets and allen keys. The prism holder (FT 01593) and the yoke 140 mm (FT 01594) can be fixed frontal into the FT 01693. The yoke can be used directly on the beams and on the front spanner to clamp square pieces as well.



FT 01697 3D swivel head IF 22



Application The 3D swivel head IF 22 can be used in combination with many F-Tool clamping elements. Furthermore, this article is compatible with some EROWA PalletSet W elements.

- Options**
- FT 01318 WEDM vise 55F18
 - FT 01319 WEDM vise 100F22
 - FT 01358 Spacer plate 100 x 29 x 4 mm.



FT 01705 3D swivel head IF 90°



Application The 3D swivel head IF 90° is used for the frontal collet of clamping elements and adapter plates.

- Options**
- FT 01326 Magnetic table 140 x 50 x 44 mm
 - FT 01339 Interface plate 146 x 56 x 16 mm.



FT 01706 3D swivel head IF 15 / 3R



Application The 3D swivel head is compatible with many 3R clamping elements.



FT 01694 IF 22 for 3D swivel head

FT 01695 IF 90° for 3D swivel head

FT 01696 IF 15 / for 3D swivel head



Application For every application the right adapter.



F-Tool WEDM Square block-index-table

FT 01791 WEDM square block-index-table 80



Application The F-Tool center chuck with spring-steel centering, 90° raster-indexation or stageless indexation with graduation. Able for the direct application on the drilling machine, on the WEDM-machine table with hole pattern 50 mm or to clamp with the F-Tool basic rulers (arbour height 50 mm). Delivered with a universal index adapter plate 80 with graduation (FT 01792) to adapt the ER chuck 80P (FT 01043), chuck 80 IF3R (FT 01044), collet chuck holder (FT 01580/FT 01581), electrodes or working pieces.

Dimension 120 x 79 x 92 mm / Spindle height 50 mm.



FT 01944 Square block for index-table and chuck 80, 120 x 79 x 92 mm



Application Angle base for chuck. Can be mounted directly on the WEDM table or on the RulerSet base.



Combination examples:

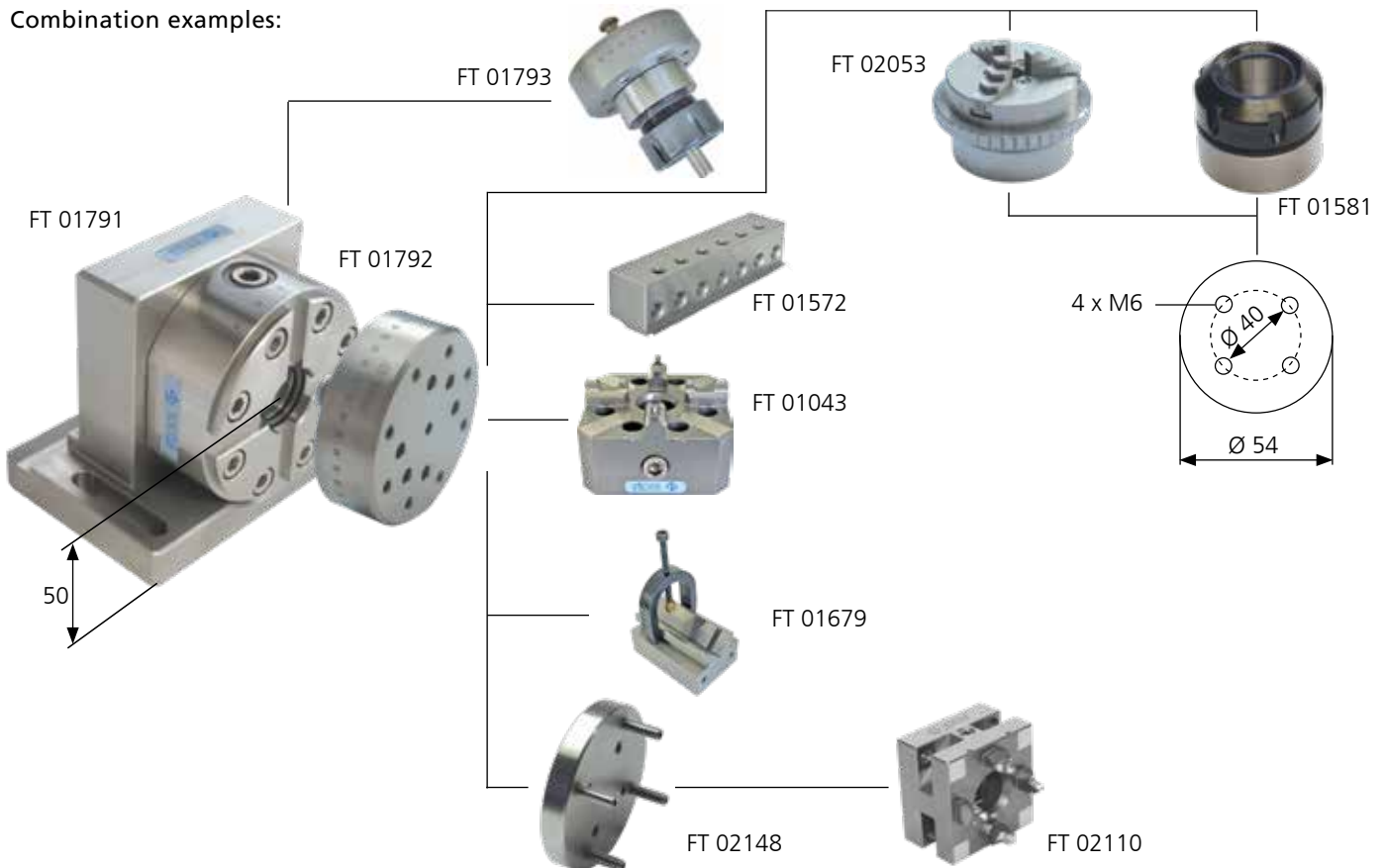

FT 01717 PIN center chuck
with graduation**FT 01716** PIN center chuck
without graduation

Version

The PIN center chuck is a compact reference system and is able for the collet of electrodes and work pieces. It's also the base of the F-Tool PIN ZeroPoint centering system. The centering, respective the positioning happens in two steps. The first step is the pre-centering with the PIN centering bolt. The precise centering is done, if the cone of the spigot is intervening on the flexible centering plate, and the piece is drawn to the clamping area. With the intervention of the PIN index 8 mm into the cross slot, the angle coat is defined.

**FT 01792** Universal index adapter plate 80
with graduation

Application

Universal adapter plate 80 with nonius-display to adapt the ER chuck 80P (FT 01043), collet chuck holder (FT 01580/ FT 01581), electrodes or working pieces. Hole pattern: 8 x M6 reference circle 61 for ER chuck 80P & chuck 80 IF3R.

Hole pattern

For 6 x M6 circle diameter 40 mm (to adapt collet chuck holder, front spanner FT 01572 or electrodes respective working pieces).

**FT 02008** Mandrin à mors 63 Inox 0-56 mm

Application

Suitable for the application on EDM wire cutting machines under water. Hardened clamping jaws for the clamping of outside diameter $\varnothing 1 - \varnothing 60$ mm and inside diameter of $\varnothing 12 - \varnothing 66$ mm. Hole pattern 4 x M6, reference circle 40 mm.

Hint

Clamping accuracy ± 0.01 mm.
Maximum work piece weight: 2 kg.



F-Tool

WEDM Accessories

FT 01071 WEDM tool set



Application The WEDM tool set contains a practical assortment of corrosion-resistant screws, keys, brackets, support plates and bases. We recommend the set to every wire EDM user.



FT 01322 Jack \varnothing 20 x 10mm for M8 ALU

FT 01323 Jack extension ALU \varnothing 20 x 20 mm

FT 01456 Jackset adjustable \varnothing 20 x 20-26 mm

FT 01492 Jack brass \varnothing 9.5 x 10 mm for M6

FT 01493 Jack extension brass \varnothing 9.5 x 20 mm



Version The jacks can be used as bracket supports or as screw extensions on the universal pallet and the miscellaneous frame pallets. The soft material prevents the marking by the brackets and the screws on the work piece.



FT 01381 Bracket 70

FT 01382 Bracket 34

FT 01383 Bracket 45 corrosion-resistant



Version Brackets for the miscellaneous clamping elements.



FT 01447 Multi bracket 60 x 26 x H6 mm



Version Brackets for the miscellaneous clamping elements.



FT 01389	Distance piece hexagonal M8 EL 40
FT 01390	Distance piece hexagonal M8 EL 60



Application Distance piece hexagonal M8.

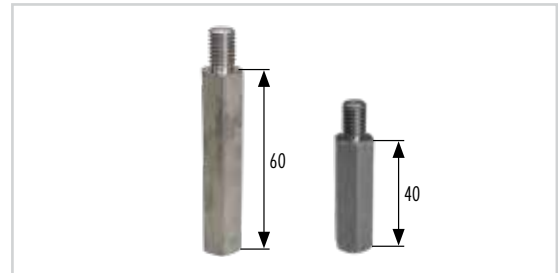

FT 01403	Allen key with hand grip 4 mm L = 100 mm
FT 01404	Allen key with hand grip 5 mm L = 150 mm
FT 01405	Allen key with hand grip 6 mm L = 150 mm



Version Allen keys with hand grip.



FT 01455	Spacer plate 28 x 14 x 2 mm for beam 75 mm (set of 2 pieces)
FT 01439	Spacer plate 60 x 20 x 3 mm for beam (set of 2 pieces)



Application Mounted under the clamping beams, the Z-support is raised by 3 mm. This ensures that the travel range of the lower rinsing nozzles is collision-free.



FT 02466	Set of spacer plate 3 mm set of 2 pieces
----------	---



Anwendung Mounted under the clamping beams, the Z-support is raised by 3 mm. This ensures that the travel range of the lower rinsing nozzles is collision-free.



F-Tool

WEDM Accessories

FT 01070 Spacer Plate 100 x 29 x 3 mm
with 2 x hole \varnothing 8 mm



Application Mounted under the clamping beams, the Z-support is raised by 3 mm. This ensures that the travel range of the lower rinsing nozzles is collision-free.



FT 01457 Spacer plate 100 x 29 x 3 mm

FT 01947 Spacer plate 60 x 29 x H3 mm

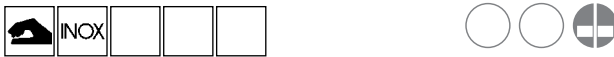

Application Mounted under the clamping beams, the Z-support is raised by 3 mm. This ensures that the travel range of the lower rinsing nozzles is collision-free.



FT 02010 Clamping unit PIN center chuck
FT 01717



Version Spare part for F-Tool PIN center chuck FT 01717.



FT 02051 Z-0 base plate 69 x 22 x 3 mm

FT 01906 Z-0 base plate 4/9 mm
69 x 31 x 3 mm



Application The Z-0 base plate, made of corrosion-resistant, grinded steel, can be assembled on beams without clamping lips. Depending on the direction, respective the clamping function, the lip overlap 4 mm or 9 mm from the support.



FT 02337 HighPower Magnet \varnothing 20 mm h7
(100 N/cm²) slug holder



Application These extra powerful mini magnetic sets are used in holding slugs during wire EDM process until the cut is finished. Avoid wire breakings and interruptions during the wire EDM process.



F-Tool Index

This is where you will find all the F-Tool order numbers in numerically ascending order, together with the numbers of the pages on which the products are presented in pictures.

Order number	Page	Order number	Page	Order number	Page	Order number	Page
FT 01043	10	FT 01456	52	FT 01835	18	FT 02106	23
FT 01063	37	FT 01457	54	FT 01858	31	FT 02107	23
FT 01064	37	FT 01483	23	FT 01859	31	FT 02108	35
FT 01065	37	FT 01486	31	FT 01860	31	FT 02110	10
FT 01070	54	FT 01487	31	FT 01862	20	FT 02120	11
FT 01071	52	FT 01492	52	FT 01863	20	FT 02128	30
FT 01077	16	FT 01493	52	FT 01864	20	FT 02131	12
FT 01079	16	FT 01568	39	FT 01865	20	FT 02132	12
FT 01081	16	FT 01569	39	FT 01866	20	FT 02133	12
FT 01084	16	FT 01570	39	FT 01867	20	FT 02134	12
FT 01085	17	FT 01572	43	FT 01873	41	FT 02135	13
FT 01092	23	FT 01581	17	FT 01877	21	FT 02136	13
FT 01129	17	FT 01600	44	FT 01878	41	FT 02137	13
FT 01131	17	FT 01675	33	FT 01882	20	FT 02138	13
FT 01318	46	FT 01679	43	FT 01883	21	FT 02139	14
FT 01319	46	FT 01690	42	FT 01884	21	FT 02140	14
FT 01322	52	FT 01693	48	FT 01885	21	FT 02141	14
FT 01323	52	FT 01694	49	FT 01886	22	FT 02142	14
FT 01326	46	FT 01695	49	FT 01887	22	FT 02143	15
FT 01327	37	FT 01696	49	FT 01888	22	FT 02144	15
FT 01333	31	FT 01697	49	FT 01905	21	FT 02149	40
FT 01334	32	FT 01705	49	FT 01906	55	FT 02150	37
FT 01342	30	FT 01706	49	FT 01920	19	FT 02194	15
FT 01344	30	FT 01716	51	FT 01921	19	FT 02307	44
FT 01345	32	FT 01717	51	FT 01924	35	FT 02333	37
FT 01346	34	FT 01760	44	FT 01925	35	FT 02337	55
FT 01347	31	FT 01762	18	FT 01926	35	FT 02349	24
FT 01348	31	FT 01764	18	FT 01927	36	FT 02351	24
FT 01349	31	FT 01768	11	FT 01928	36	FT 02352	24
FT 01350	42	FT 01769	11	FT 01929	36	FT 02354	24
FT 01351	43	FT 01780	31	FT 01934	36	FT 02443	10
FT 01352	33	FT 01789	34	FT 01944	50	FT 02465	38
FT 01381	52	FT 01790	42	FT 01947	54	FT 02466	54
FT 01382	52	FT 01791	50	FT 01951	42	FT 02467	38
FT 01383	52	FT 01792	51	FT 01952	43	FT 02468	38
FT 01389	53	FT 01793	18	FT 02008	51	FT 02469	38
FT 01390	53	FT 01809	19	FT 02010	55	FT 02473	38
FT 01403	53	FT 01810	19	FT 02011	20	FT 02482	38
FT 01404	53	FT 01811	19	FT 02038	22		
FT 01405	53	FT 01813	22	FT 02044	32		
FT 01420	33	FT 01820	31	FT 02045	32		
FT 01435	16	FT 01825	39	FT 02046	34		
FT 01439	54	FT 01826	38	FT 02047	34		
FT 01447	53	FT 01827	38	FT 02051	55		
FT 01455	54	FT 01828	38	FT 02097	40		

The next step

Important things need to be planned. And your next step is certainly among the important things. It is your start into a new, efficient era. We are pleased to be with you on the way. As consultants, in practice. For you to know at all times what you're engaging in. The next EROWA branch office is not far – **take the step.**

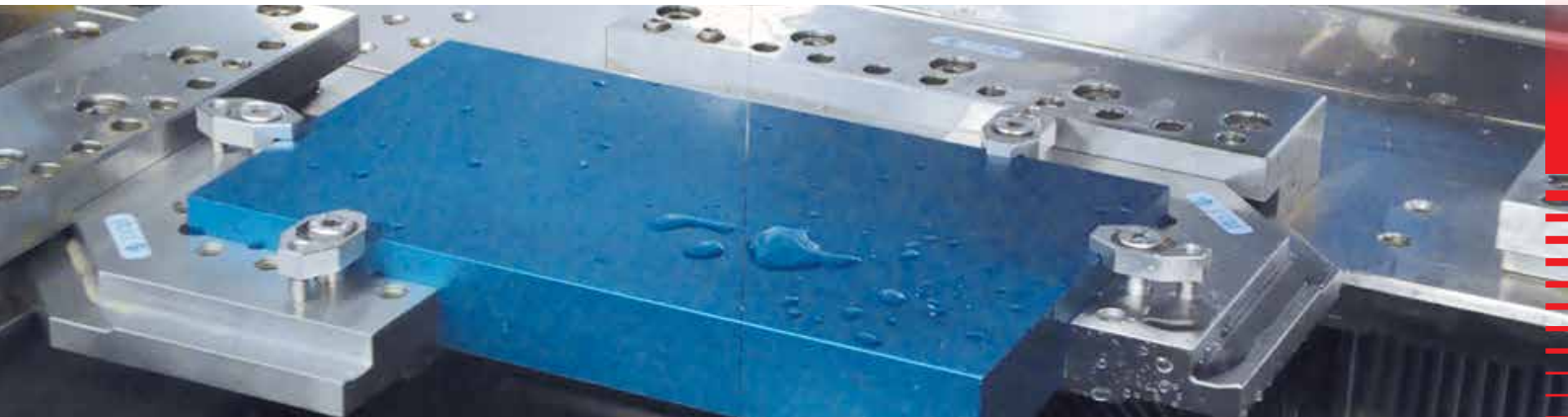

USA

EROWA Technology, Inc.
North American Headquarters
2535 South Clearbrook Drive
Arlington Heights, IL 60005
USA
Tel. 847 290 0295
Fax 847 290 0298
e-mail: info@erowa.com
www.erowa.com

Italy

EROWA Tecnologie S.r.l.
Sede Legale e Amministrativa:
Via Alfieri Maserati 48
IT-10095 Grugliasco (TO)
Italy
Tel. 011 9664873
Fax 011 9664875
info@erowa.it
www.erowa.com

Unità di Treviso:
Via Leonardo Da Vinci 8
IT-31020 Villorba (TV)
Italy
Tel. 0422 1627132

Singapore

EROWA South East Asia Pte. Ltd.
56 Kallang Pudding Road
#06-02, HH@Kallang
Singapore 349328
Singapore
Tel. 65 6547 4339
Fax 65 6547 4249
sales.singapore@erowa.com
www.erowa.com

Japan

EROWA Nippon Ltd.
Sibadaimon Sasano Bldg.
2-6-4, Sibadaimon, Minato-ku
105-0012 Tokyo
Japan
Tel. 03 3437 0331
Fax 03 3437 0353
info@erowa.co.jp
www.erowa.com

Switzerland

EROWA AG
Knutwilerstrasse 3
CH-6233 Büron
Switzerland
Tel. 041 935 11 11
Fax 041 935 12 13
info@erowa.com
www.erowa.com

France

EROWA Distribution France Sàrl
PAE Les Glaisins
12, rue du Bulloz
FR-74940 Annecy-le-Vieux
France
Tel. 4 50 64 03 96
Fax 4 50 64 03 49
erowa.france@erowa.com
www.erowa.com

Spain

EROWA Technology Ibérica S.L.
c/Via Trajana 50-56, Nave 18
E-08020 Barcelona
Spain
Tel. 093 265 51 77
Fax 093 244 03 14
erowa.iberica.info@erowa.com
www.erowa.com

China

EROWA Technology (Shanghai) Co., Ltd.
G/F, No. 24 Factory Building House
69 Gui Qing Road (Caohejing Hi-tech Park)
Shanghai 200233, PRC
China
Tel. 021 6485 5028
Fax 021 6485 0119
info@erowa.cn
www.erowa.com

Germany

EROWA System Technologien GmbH
Gewerbegebiet Schwadernmühle
Roßendorfer Straße 1
DE-90556 Cadolzburg/Nbg
Germany
Tel. 09103 7900-0
Fax 09103 7900-10
info@erowa.de
www.erowa.de

Scandinavia

EROWA Technology Scandinavia A/S
Kærvej 39
DK-5220 Odense SØ
Denmark
Tel. 65 98 26 00
Fax 65 98 26 06
info.scandinavia@erowa.com
www.erowa.com

Eastern Europe

EROWA Technology Sp. z o.o.
Eastern Europe
ul. Spółdzielcza 37-39
55-080 Kąty Wrocławskie
Poland
Tel. 71 363 5650
Fax 71 363 4970
info@erowa.com.pl
www.erowa.com

India

EROWA Technology (India) Private Limited
No: 6-3-1191/6, Brij Tarang Building
Unit No-3F, 3rd Floor, Greenlands, Begumpet,
Hyderabad 500016 (Telangana)
India
Tel. 040 4013 3639
Fax 040 4013 3630
sales.india@erowa.com
www.erowa.com